

Electronic Stethoscope

(Model: HC-21)

Xiamen Linktop Technology Co., Ltd.

User Manual

(Version: A/0)

Foreword

This manual is a part of a medical product - the Electronic Stethoscope.

Linktop bears no liability and provides no guarantee with regard to damage (including indirect damage) arising due to this user manual not being complied with.

- Prior to using the medical product, it is required to read this user manual carefully.
- The user manual should be kept in a safe place for the whole duration of using the medical product.
- It should be provided to every subsequent owner or user of this medical product.
- It should be updated on the basis of every supplementation received from the product manufacturer.

The aim of this manual is to describe a medical product – the Electronic Stethoscope – taking into account the following in particular:

- Description of the medical product,
- Safety of use,
- Maintenance,
- Troubleshooting,
- Servicing.

1. SAFETY GUIDE

Please read the entire instruction manual before you use Electronic Stethoscope. It will give you a better understanding of how the product works.

1.1 Warnings

- Using this medical product is not a substitute for visiting a physician and may not delay obtaining medical assistance in sudden pathological conditions.
- This medical product can be operated by adults only.
- Do not perform auscultation with this medical product if there are any wounds or abrasions within the spot examined.
- In the event when the user of this medical product has a pacemaker implanted, the admissibility of using this medical product should be consulted with a physician.
- The device is sensitive to external factors - noises or murmurs may have a negative impact on the quality of recordings.
- This medical product is not intended for diagnostics in emergency conditions! If you suspect any hazard to life or health (e.g. trouble breathing, impaired consciousness, significantly increased respiratory rate, panic), do not use this medical product! In such a situation, contact a doctor urgently.
- This medical product includes small elements that can be ingested or aspirated: keep the product and its accessories away from children.
- The power supply cable may constitute a strangulation hazard: any examination of children should be conducted under supervision.
- Only Magnetic USB cable paired with a charger provided by the manufacturer – or a charger with parameters consistent with those specified in this manual – should be used for charging the device.
- Do not perform examinations with the stethoscope or put it to the body while it is being charged.
- Do not attempt to replace the battery on your own.
- Prior to commencing examination, please disconnect the charging cable from the stethoscope!
- In case of noticing any irregularities in functioning of the stethoscope or any damage to it, stop using it immediately and contact the manufacturer.
- Prior to using the stethoscope, make sure that it has no visible damage.
- The stethoscope should not be opened or modified.
- The stethoscope should not be immersed in water or other liquids.

1.2 Precautions

- This medical product is an electronic stethoscope. It should be used solely for recording the respiratory system or heart auscultation sounds. This medical product does not analyze the sounds recorded.
- A recording made using this medical product may be transmitted only via applications approved by Linktop. The recordings made using any applications other than those specified below may not be reliable, which may lead to their content being interpreted

incorrectly by a doctor and, in consequence, to incorrect diagnosis. The list of approved applications is available at the www.linktop.com website.

- Do not expose the product to impact of any chemical substances, sunlight, or high temperature.
- Protect the stethoscope against shocks and falls.
- The product should be used in ambient temperature from 15 to 40° C.
- Do not expose the stethoscope to temperatures greater than 50° C or lower than 0° C.
- Do not use the product when the relative humidity exceeds 90%.
- In case of noticing any irregularities in functioning of the stethoscope or any damage to it, stop using it immediately and contact the manufacturer.
- The product should be stored in a clean and dry place.
- This medical product is not sterile and must not be sterilized.
- The stethoscope should be charged only by means of the charging cable included in the set supplied. In any other case, use a charger that meets the requirements described of this manual.
- When the product is being charged, all its functions, including data transmission, are blocked.
- The stethoscope does not include any parts that can be replaced by the user on their own.
- If you experience any skin irritation or redness after use this device, please stop using the device.

1.3 Contraindications

- N/A

1.4 Adverse Reactions

- N/A

1.5 Special Population

- N/A

1.6 Intended Use/Indications for Use

The Electronic Stethoscope is intended for the detection, amplification and recording of sounds from the heart, lungs, anterior and posterior chest with selective frequency ranges. It can be used on any person undergoing a physical examination.

2. DEVICE DESCRIPTION

2.1 General Description

Electronic stethoscope's proprietary environmental noise cancellation technology can help you hear the human body's important heart and lung sounds. This technology can reduce background noise by an average of 85%, but will not filter out important auscultation sounds. Electronic stethoscope is compatible with both headset auscultation and Bluetooth recording auscultation, which is convenient for doctors in clinical diagnosis or remote auscultation. The

excellent acoustic sensitivity and high-quality sound transmission of this product provide reliable performance and comfortable experience for medical professionals who are committed to achieving the best patient care.

2.2 Device Drawing

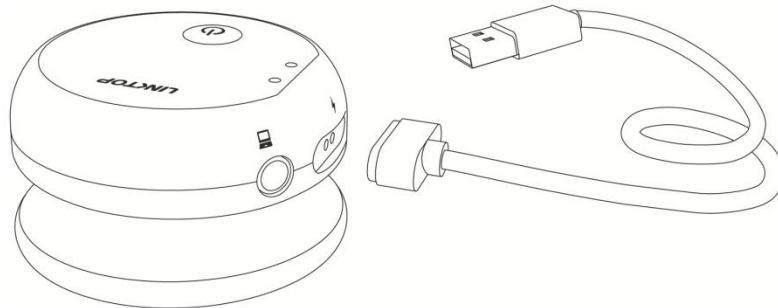

Figure 1. Device Drawing

2.3 Device Components

The main elements of the stethoscope are presented on Figure 2.





Figure 2. Device Components

Description of each component	
①	Power button: Power on/off and Bluetooth pairing Button.
②	Indicator light: Two color LEDs
③	PC socket: 3.5 mm mini jack socket – used for connecting PC or Mobile phone to record
④	Charge port: Magnetic USB interface – used for charging
⑤	Headphones socket: 3.5 mm mini jack socket – used for connecting headphones
⑥	Membrane
⑦	Audio jack silicone plug – used for waterproof and dustproof of the audio jack.

The table below includes the description of the Button and LEDs on the stethoscope:

	In the shutdown state, Long press the button 3 seconds to turn on
	In the power-on state, Long press the button 3 seconds to power off

	In the working mode, short press the button to enter sleep mode
	In the working mode, double press the button to switch auscultation mode (heart sound auscultation and lung sound auscultation mode)
	Green light is always on in lung sound auscultation mode when Bluetooth connected
	Green light flashes slowly when charging
	Green light is always on when fully charged
	Blue light is always on in heart sound auscultation mode when Bluetooth connected

2.4 Specifications

Product Name	Electronic Stethoscope
Model	HC-21
Power supply	5V DC 500mA (lithium-ion battery)
Dimensions	Height 1.02 inches (26mm) Base diameter 1.77 inches (45 mm) Membrane diameter 1.7 inches (43.8 mm)
Weight	62g
Battery life	More than 500 charging cycles
Frequency range	RF: ISM, 2.402-2.480GHz
Attenuation	100Hz-500Hz ≤ 12dB 600Hz-1000Hz ≤ 20dB
Modulation	GFSK
RF power	4.5 dBm
Bluetooth version	Bluetooth 5.0
Type of application parts applied	BF
Protection class	IP22

3. USING INSTRUCTIONS

3.1 Preparations for use

3.1.1 Application

Prior to using the stethoscope, it is necessary to confirm whether your mobile phone is supported by stethoscope. The available mobile phones are as follows:

- (1) Mobile phone or tablet with Android 7.0 or higher and Bluetooth 4.2,
- (2) iPhone that supports Bluetooth 4.2, such as: iPhone 7 / 7 Plus / 8 / 8 Plus / X / XR / Xs / Xs Max / 11 pro / 11 pro Max / 12 mini / 12 / 12 pro / 12 pro Max.

Note: Always use the most recent version of the application ("NexStetho" application). You can download it from Official website: <https://www.linktop.com>, Google Play or App Store.

3.1.2 Electronic Stethoscope

- (1) When using the stethoscope for the first time, long press the power button 3 seconds to power on.
- (2) If the battery of the device is low, it will not be able to start up. Connect the magnetic cable included in the set to the charging interface of the stethoscope to charge it (Figure 3) and remove it after it is fully charged.

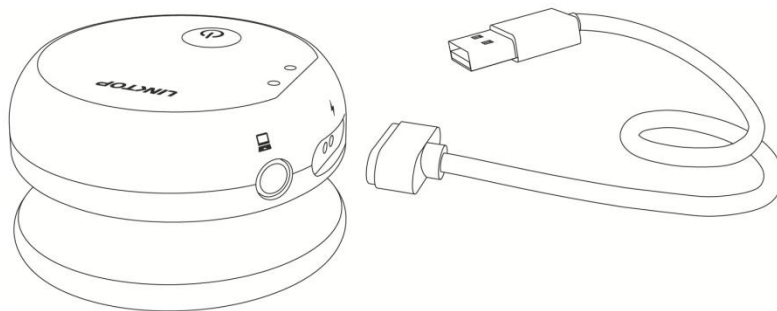

Figure 3. Charging demo

Note: When the battery of the stethoscope is charged, the green LED is flashing, When the green LED is always on, means fully charged, you can disconnect the cable.

- (3) In order to charge the stethoscope, it is necessary to connect it to a charger using only the cable provided. In any other case the cable should be connected to a charger that meets the requirements described in this manual. After connecting the stethoscope to the charger, it should be left until fully charged (when the charging LED is always on).

Note: When the stethoscope is being charged, all its function is blocked.

3.1.3 Activities during operation

The stethoscope can be used in one of the three modes listed below:

- ① Use the application to connect with Electronic Stethoscope via Bluetooth.
- ② Use the application to connect with Electronic Stethoscope via 3.5mm audio cable.
- ③ Use headphones to connect stethoscope for auscultation.



When recording, make sure that the jack socket is not covered and do not knock on the casing. After putting the stethoscope to the body, click [Start] button to start recording on the application, and the application will show information on the recording progress.

1. Patient auscultation mode using the application to connect with Electronic Stethoscope via Bluetooth

- (1) Use an Android phone to download the "NexStetho" application from Google Play or

use an iPhone to download the "NexStetho" application from the APP Store.

- (2) Please make sure that the Bluetooth of the mobile phone is open, and the stethoscope is turned on.
- (3) Launch the "NexStetho" application, click "Add Device", the application will search for the Bluetooth of the stethoscope until it finds a device with the Bluetooth name "HC-21", select and connect, the application will automatically bind the stethoscope.
- (4) Use the application to select the auscultation mode and confirm whether to use the heart sound auscultation or lung sound auscultation mode.
 - The heart sound auscultation mode is suitable for low-frequency sounds in auscultation, such as the first heart sound, the second heart sound, the rumbling diastolic murmur of mitral valve stenosis, etc. When using it, touch the body surface to be checked lightly, but care should be taken to avoid body parts and Additional sound caused by skin friction.
 - The lung sound auscultation mode is suitable for high-pitched sounds in auscultation, such as murmurs of aortic regurgitation, breathing sounds, bowel sounds, etc. When using it, touch the body surface to be inspected tightly.
- (5) Select the auscultation site and confirm whether to auscultate the lung or the heart.
- (6) Putting the stethoscope membrane (Figure 4) to the patient's body at specific spots indicated by the doctor, and holding it at each spot, click the start button in the application to record until the auscultation time is sufficient, click the stop button to end the recording.

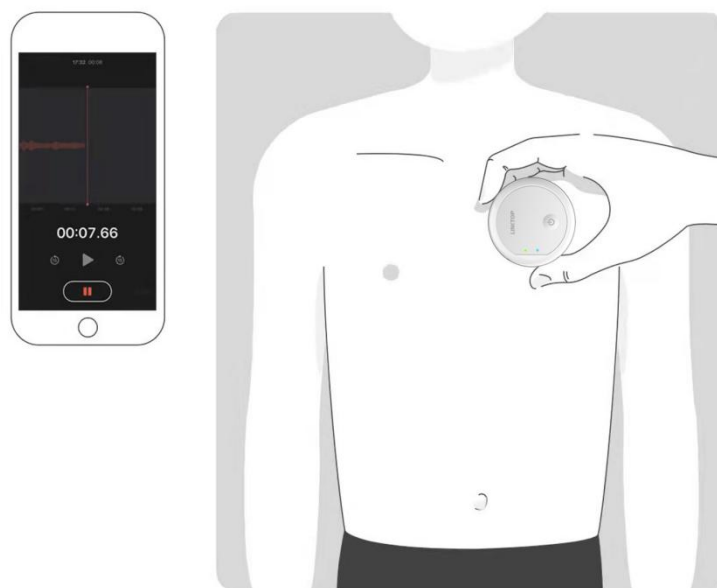

Figure 4

- (7) It is recommended to record sound at all the spots indicated by the doctor.
- (8) If you hear that the quality of sound recorded at some spots is poor, it is necessary to repeat recording at those spots.

2. Patient auscultation mode using the application to connect with Electronic Stethoscope via 3.5mm audio cable

It is necessary to launch the Recording application, connect the stethoscope via 3.5mm mini jack cable.



The stethoscope only supports connecting with Windows PC, and only supports recording APP: Voice Recorder.

- (1) Select the auscultation site and confirm whether to auscultate the lung or the heart.
- (2) Putting the stethoscope membrane (Figure 5) to the patient's body at specific spots indicated by the doctor, and holding it at each spot, click the start button in the application to record until the auscultation time is sufficient, click the stop button to end the recording.

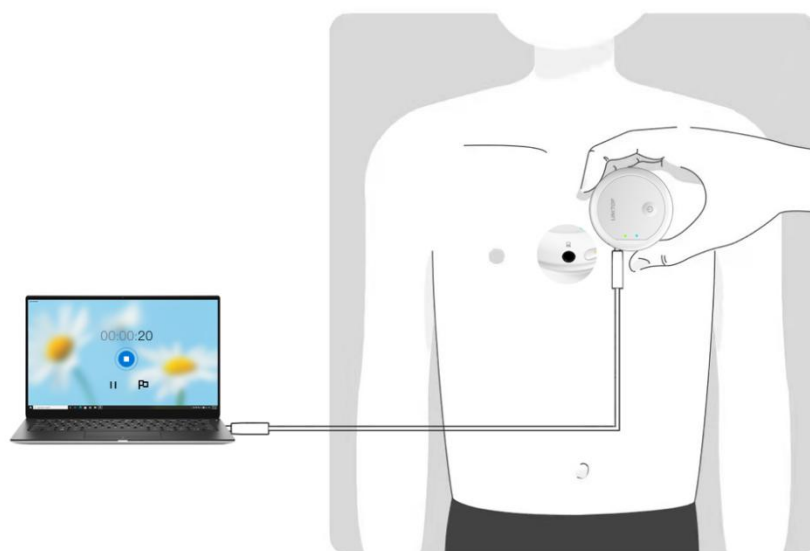

Figure 5

- (3) It is recommended to record sound at all the spots indicated by the doctor.
- (4) If you hear that the quality of sound recorded at some spots is poor, it is necessary to repeat recording at those spots.

3. Patient auscultation mode using headphones to connect Electronic Stethoscope

In this mode, no need to connect the application, it needs to connect headphones to the 3.5 mm mini jack socket.

The stethoscope LED will show a blue flashing indicator that the heart auscultation filter is active. After double pressing the stethoscope button, the filter will be switched to the lung auscultation mode, the stethoscope LED will show a green flashing indicator.



Although it is possible to use various type of headphones, in view of the range of frequencies present in auscultation sound signals and levels thereof it is recommended to

use headphones with minimum impedance of 16 Ohm and bandwidth of at least 20 – 20KHz during auscultation.

3.1.4 Turning the stethoscope off

If you do not use the stethoscope, you can press the stethoscope button to put it into sleep mode. It is not necessary to turn it off after each use.

If it is necessary to turn off the stethoscope completely, it can be done by pressing and holding the stethoscope button for 3 seconds. To turn on the stethoscope again, it is enough to press and hold the stethoscope button for 3 seconds.

Note: If the stethoscope is not turned off when it is not in use, the stethoscope may run out of battery power.

4. CLEANING AND MAINTENANCE

The stethoscope should be disinfected after each use. It should be disinfected using a cotton pad or swab moistened with non-alcoholic disinfectant intended for medical products.

- Please take care not to flood the 3.5 mm jack socket with the disinfectant.
- Do not immerse the stethoscope in water or other cleaning liquids and do not clean it under running water.
- Make sure that the water does not reach the inside of the stethoscope.

5. STORAGE, TRANSPORT AND OPERATION CONDITIONS

5.1 Storage and transport conditions:

Temperature: -20°C do 60°C

Relative humidity: 10% do 95%

Atmospheric pressure: 700 hPa ~1060 hPa

5.2 Operation conditions:

Temperature: 5°C to 40°C

Relative humidity: from 10% to 95%

Atmospheric pressure: 700 hPa ~1060 hPa

6. TROUBLE SHOOTING

Malfunctions	Reason	Solution
APP cannot connect to the device via Bluetooth	Bluetooth is not in pairing state	The device enters sleep mode, short press the button to enter working mode.
		The device is turned off, long press the button for 3 seconds to turn on the device.
Incomplete sound transmission via Bluetooth	Wrong connection distance	Keep the distance between the app and the device within 2 meters
	Bluetooth version is low	Must use Bluetooth 4.2 or higher mobile phone or tablet

Serious recording noise	Noise caused by skin friction	Touch the body surface to be checked lightly, but care should be taken to avoid body parts and Additional sound caused by skin friction.
-------------------------	-------------------------------	--

7. SERVICING

In case of noticing any irregularities in functioning of the medical product, contact the maintenance service at the e-mail address: support@linktop.com
 Linktop bears no liability and provides no guarantee with regard to damage (including indirect damage) arising due to this user manual not being complied with.

8. WARRANTY

The warranty-related information regarding warranty duration, its scope, its territorial range, and the rights in case of finding a defect are described in detail at the address: www.linktop.com.





Note: The device and accessories out of shelf life or use life should not be thrown randomly and should be recycled by the manufacturer.













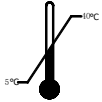

To dispose of packing materials, take appropriate actions in accordance with the rules and regulations in force in your area to prevent adverse ecological effects.

9. PACKAGE CONTENTS

- (1) Electronic Stethoscope × 1
- (2) User manual × 1
- (3) Magnetic USB charging cable × 1
- (4) Audio jack silicone plug x 2

10. LABEL SYMBOLS

1.		Symbol for "MANUFACTURER". This symbol shall be accompanied by the name and the address of the manufacturer.
2.		Serial number
3.		DATE OF MANUFACTURE. This symbol shall be accompanied by a date to indicate the date of manufacture.
4.		Symbol for "AUTHORISED REPRESENTATIVE IN THE EUROPEAN COMMUNITY". This symbol shall be accompanied by the name and the address of the authorized representative in the European Community, adjacent to the symbol.
5.		Collect separately from other household waste
6.	IP22	IP classification

7.		Refer to user manual
8.		Type BF Applied Part
9.		Symbol for "ATTENTION" Caution! Follow operating instructions! Failure to do so could place the patient or operator at risk.
10.		Conformity indication with the essential health and safety requirements set out in European Directives.
11.		Atmospheric pressure limitation
12.		Batch code
13.		Catalogue number
14.		Temperature limit
15.		Keep away from sunlight
16.		Keep away from rain
17.		Do not use if package is damaged
18.		Class II equipment
19.		Humidity limitation
20.		Fragile; handle with care
21.		Use by date
22.		Symbol for "IMPORTER". This symbol shall be accompanied by the name and the address of the importer, adjacent to the symbol.

11. ELECTROMAGNETIC COMPATIBILITY

The Electronic Stethoscope has been tested and found to comply with the electromagnetic compatibility (EMC) limits for medical devices. These limits are designed to provide reasonable protection against harmful interference in a typical medical installation.

a) Do not use a mobile phone or other devices that emit electromagnetic fields, near the unit. This may result in abnormal operation of the unit.

b) Caution: This unit has been thoroughly tested and inspected to assure proper performance and operation!

c) Caution: this machine should not be used adjacent to or stacked with other equipment and that if adjacent or stacked use is necessary, this machine should be observed to verify normal operation in the configuration in which it will be used.

Manufacturer’s declaration – electromagnetic emissions

The Electronic Stethoscope is intended for use in the electromagnetic environments specified below. The customer or the user of the Electronic Stethoscope should assure that it is used in such an environment.		
Emissions test	Compliance	Electromagnetic environment - guidance
RF emissions CISPR 11	Group 1	The Electronic Stethoscope use RF energy only for its internal function. Therefore, its RF emissions are very low and are not likely to cause any interference in nearby electronic equipment.
RF emissions CISPR 11	Class B	The Electronic Stethoscope is suitable for use in all establishments, including domestic establishments and those directly connected to the public low-voltage power supply network that supplies buildings used for domestic purposes.
Harmonic emissions IEC 61000-3-2	Not applicable	
Voltage function / flicker emissions IEC 61000-3-3	Not applicable	

Manufacturer’s declaration – electromagnetic immunity

The Electronic Stethoscope is intended for use in the electromagnetic environment specified below. The customer or the user of the Electronic Stethoscope should assure that it is used in such an environment.			
Immunity test	IEC 60601 test level	Compliance level	Electromagnetic environment - guidance
Electrostatic discharge (ESD) IEC 61000-4-2	±8kV contact ±2, 4, 8, 15kV air	±8kV contact ±2, 4, 8, 15kV air	Floors should be wood, concrete or ceramic tile. If floors

			are covered with synthetic material, the relative humidity should be at least 30%.
Electrostatic transient / burst IEC 61000-4-4	±2kV for power supply lines ±1kV for input/output lines	Not applicable (Battery operated device)	Mains power quality should be that of a typical commercial or hospital environment.
Surge IEC 61000-4-5	±1kV differential mode ±2kV common mode	Not applicable (Battery operated device)	Mains power quality should be that of a typical commercial or hospital environment.
Voltage dips, short interruptions and voltage variations on power supply input lines IEC 61000-4-11	<5% UT (>95% dip in UT) for 0.5 cycle 40% UT (60% dip in UT) for 5 cycles 70% UT (30% dip in UT) for 25 cycles <5% UT (>95% dip in UT) for 5 sec	Not applicable (Battery operated device)	Mains power quality should be that of a typical commercial or hospital environment. If the user of the Electronic Stethoscope requires continued operation during power mains interruptions, it is recommended that the Electronic Stethoscope be powered from an uninterruptible power supply or a battery.
Power frequency (50/60 Hz) magnetic field IEC 61000-4-8	30 A/m	30 A/m	Power frequency magnetic fields should be at levels characteristic of a typical location in a typical commercial or hospital environment.

NOTE U_T is the a.c. mains voltage prior to application of the test level.

Manufacturer’s declaration – electromagnetic

The Electronic Stethoscope is intended for use in the electromagnetic environment specified below. The customer or the user of the Electronic Stethoscope should assure that it is used in such an environment.

Immunity test	IEC 60601 test level	Compliance level	Electromagnetic environment - guidance
---------------	----------------------	------------------	--

<p>Conducted RF IEC 61000-4-6</p>	<p>3Vrms 150kHz to 80MHz</p>	<p>Not applicable (Battery operated device)</p>	<p>Portable and mobile RF communications equipment should be used no closer to any part of the Electronic Stethoscope, including cables, than the recommended separation distance calculated from the equation application to the frequency of the transmitter.</p> <p>Recommended separation distance</p> $d = 1,2\sqrt{P}$
<p>Radiated RF IEC 61000-4-3</p>	<p>10V/m 80MHz to 2.7GHz</p>	<p>10V/m</p>	$d = 1,2\sqrt{P} \quad 80 \text{ MHz to } 800 \text{ MHz}$ $d = 2,3\sqrt{P} \quad 800 \text{ MHz to } 2,7 \text{ GHz}$ <p>Where p is the maximum output power rating of the transmitter in watts(W) according to the transmitter manufacturer and d is the recommended separation distance in meter (m)</p> <p>Field strengths from fixed RF transmitters, as determined by an electromagnetic site survey, ^a should be less than the compliance level in each frequency range. ^b</p> <p>Interference may occur in the vicinity of equipment marked with the following symbol:</p> 
<p>NOTE 1 At 80 MHz and 800 MHz, the higher frequency range applies. NOTE 2 These guidelines may not apply in all situations. Electromagnetic is affected by absorption and reflection from structures, objects and people.</p>			
<p>^a Field strengths from transmitters, such as base stations for radio (cellular/cordless) telephones and land mobile radios, amateur radio, AM and FM radio broadcast and TV broadcast cannot be predicted theoretically with accuracy. To assess the electromagnetic environment due to fixed RF transmitters, an electromagnetic site survey should be considered. If the measured field strength in the location in which the Electronic Stethoscope</p>			

is used exceeds the applicable RF compliance level above. The Electronic Stethoscope should be observed to verify normal operation. If abnormal performance is observed, additional measures may be necessary, such as reorienting or relocating the Electronic Stethoscope.

^b Over the frequency range 150kHz to 80 MHz, filed strengths should be less than 3V/m.

Recommended separation distances between portable and mobile

Test Frequency (MHz)	Band (MHz)	Service	Modulation	Maximum Power (W)	Distance (m)	Immunity Test Level (V/m)
385	380-390	TETRA 400	Pulse modulation 18 Hz	1.8	0.3	27
450	430-470	GMRS 460, FRS 460	FM ±5 KHz deviation 1KHz sine	2	0.3	28
710	704-787	LTE 13, 17 Band	Pulse modulation 2170.2 Hz	0.2	0.3	9
745						
780						
810	800-960	GSM 800/900, TETRA 800, iDEN 820, CDMA 850, LTE 5 Band	Pulse modulation 18 Hz	2	0.3	28
870						
930						
1720	1700-1990	GSM 1800 ,	Pulse modulation 2172	2	0.3	28

1845		CDMA 1900, GSM 1900, DECT, LTE 1, 3, 4, 25 Band, UMTS	Hz			
1970						
2450	2400-2570	Bluetooth, WLAN 802.11 b/g/n, RFID 2450, LTE 7 Band	Pulse modulation 2172 Hz		0.3	28
5240	5100-5800	WLAN 802.11 a/n	Pulse modulation 2170.2 Hz		0.3	9
5500						
5785						

12. Statement

Hereby, Xiamen Linktop Technology Co., Ltd., declares that this Electronic Stethoscope is in compliance with the essential requirements and other relevant provisions of Directive 2014/53/EU.

The full test of the EU declaration of conformity is available at the following internet address: www.linktop.com



Xiamen Linktop Technology Co., Ltd.

Address: Room 501-2,502,503, North Building, Torch Hi-Tech Zone, No.56-58 Huoju Road, Xiamen, 361000, Fujian, P.R. China.

Website: www.linktop.com